

SINGLE DOOR ASSEMBLIES (TOP (FAN) LIGHTS ARE AVAILABLE FOR SINGLE DOORS ONLY, AS SHOWN)

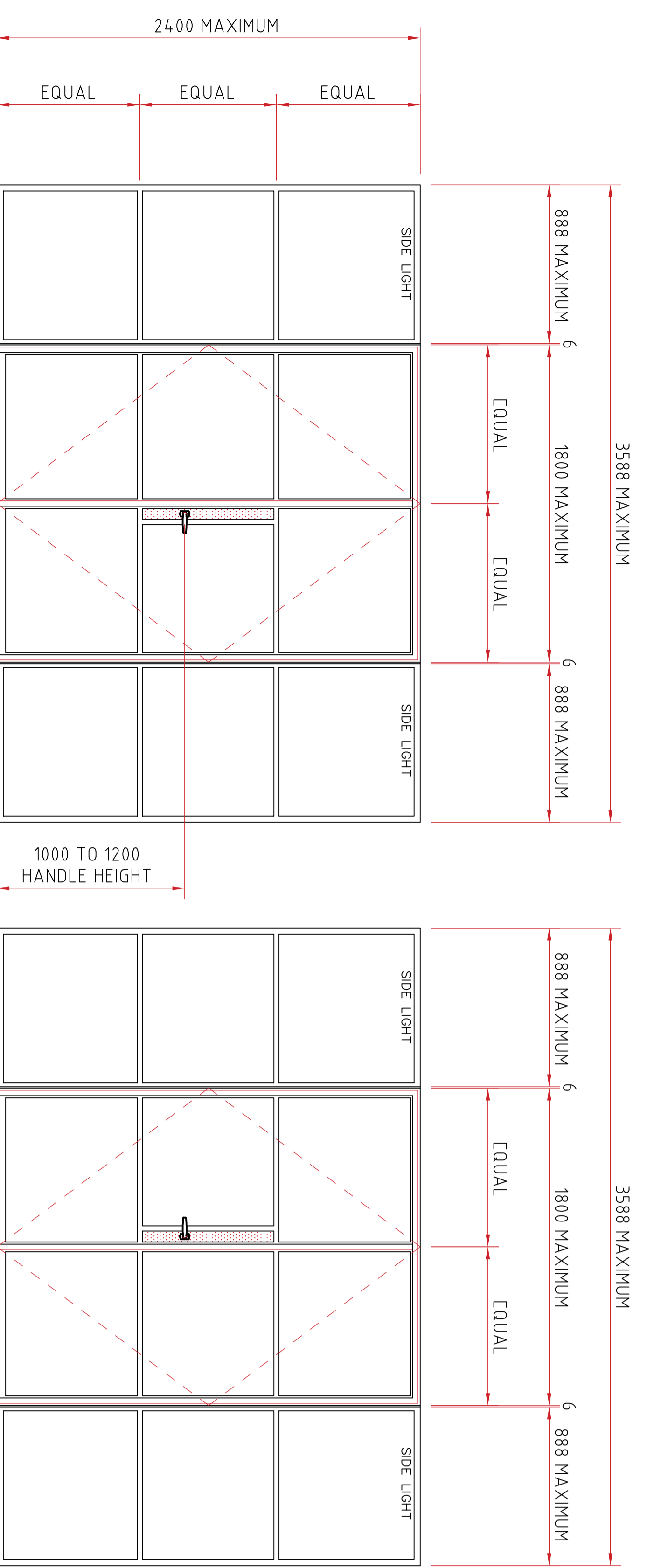

DOUBLE DOOR ASSEMBLIES

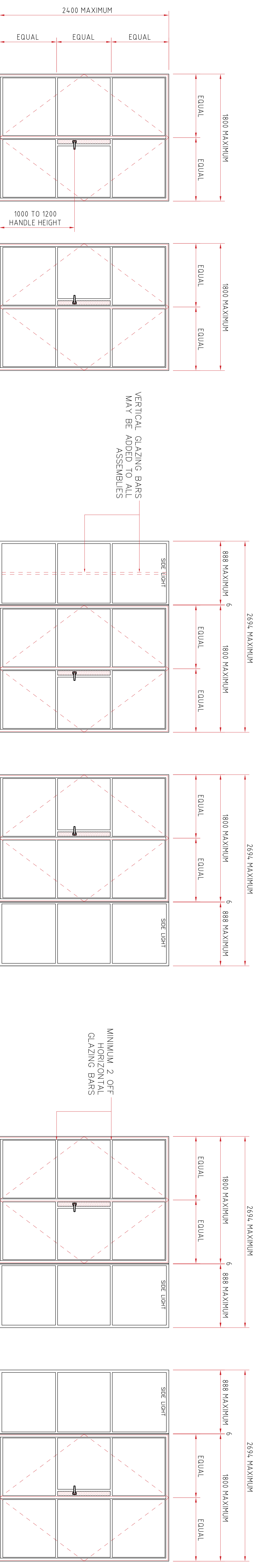
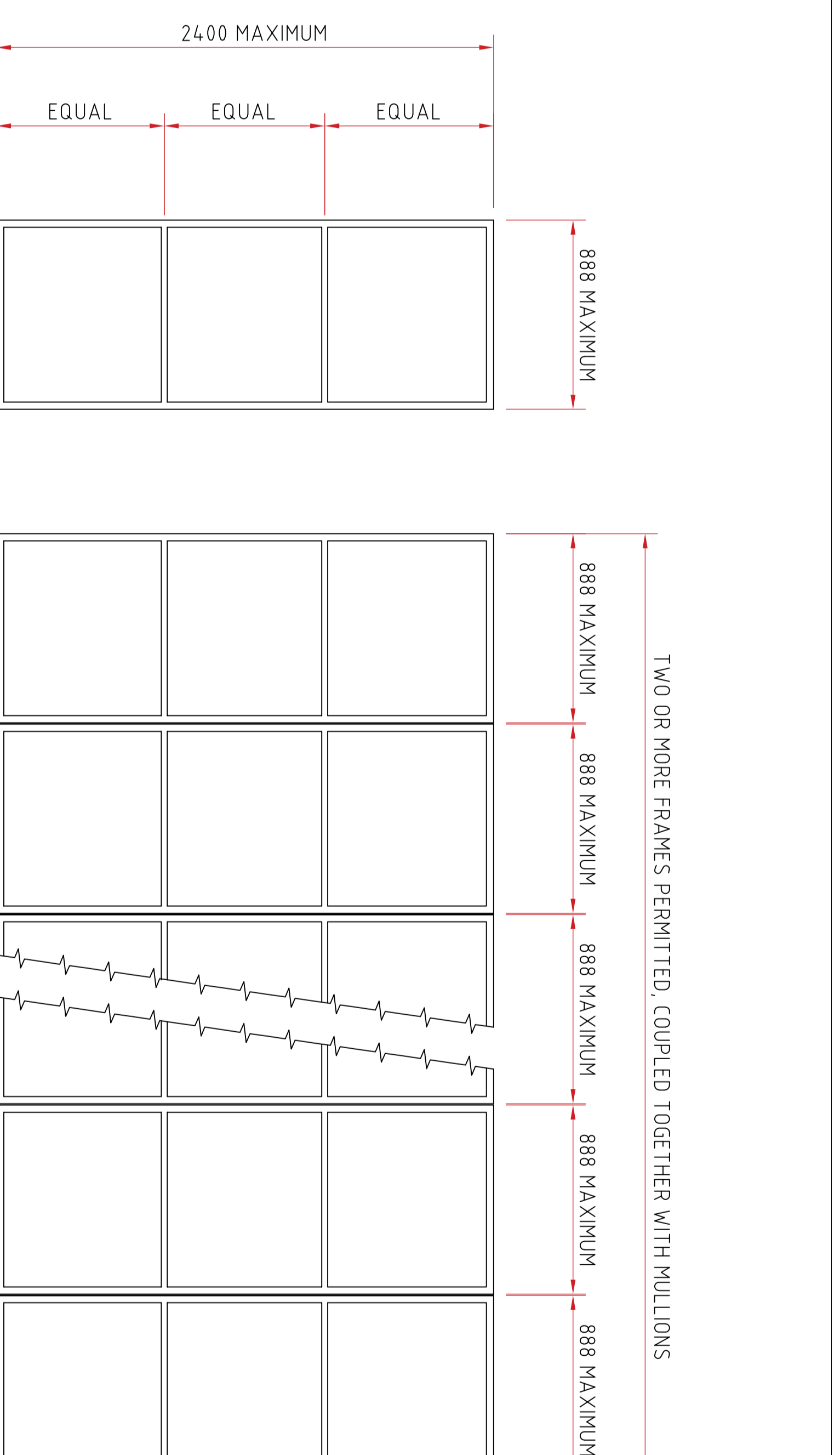

FIXED LIGHTS

THE ITEMS SHOWN ARE FIRE TESTED TO BS 476 PART 22 (FD30, 30 MINUTES INTEGRITY)

WARRINGTON EXOVA TEST REPORTS 400727 & 400728 REFER

THESE DOORS ARE TESTED AS 'PASSIVE' TYPES, I.E. DOORS MUST NOT BE OPENED DURING FIRE EXPOSURE. ALL DOORS MUST OPEN TOWARDS THE FIRE SIDE, AND MUST BE GLAZED FROM THE NON-FIRE SIDE.

FIXED LIGHTS CAN BE SUPPLIED AS PART OF A DOOR SCREEN, IN CONFIGURATIONS AS SHOWN, AND ARE AVAILABLE WITH LONG EQUAL LEG FRAME AT BOTH JAWBS (MAXIMUM FRAME WIDTH = 888mm) OR WITH LONG EQUAL LEG TO STRUCTURE AND SHORT EQUAL LEG TO COUPLING (MAXIMUM FRAME WIDTH = 875mm). CONFIGURATIONS WITH SHORT EQUAL LEG TO BOTH JAWBS ARE NOT PERMITTED.

TOP (FAN) LIGHTS CAN BE SUPPLIED WITH SINGLE DOORS ONLY, UP TO A MAXIMUM COMBINED ASSEMBLY HEIGHT OF 2606mm. THEY CANNOT BE COUPLED TO FIXED LIGHTS, OR TO DOUBLE DOORS.

STAND-ALONE FIXED LIGHTS ARE PERMITTED, AND MAY BE COUPLED TOGETHER TO FORM A SCREEN. THE SAME RULES APPLY TO THE JAWBS OF STAND-ALONE FIXED LIGHTS AS FOR THOSE COUPLED TO DOORS.

ONLY THOSE FRAME SECTIONS SHOWN WITHIN THIS DRAWING SET MAY BE USED FOR FIRE-RATED DOORS, AND ONLY IN THE POSITIONS DICTATED.

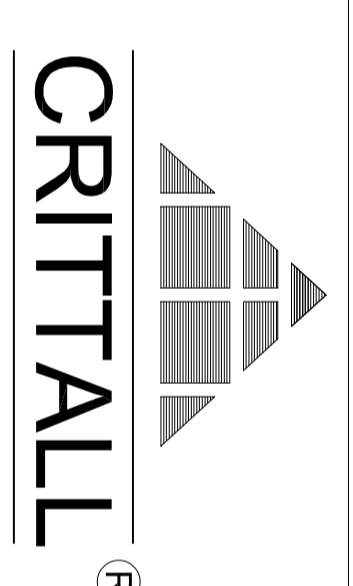

INNERVISION™ FR - FD30 FIRE RATED DOORS & FIXED LIGHTS - GENERAL ARRANGEMENT

REF: IVB 03/22 SHEET 1 OF 2

CRITTALL® IS A REGISTERED TRADE MARK OF CRITTALL WINDOWS LIMITED



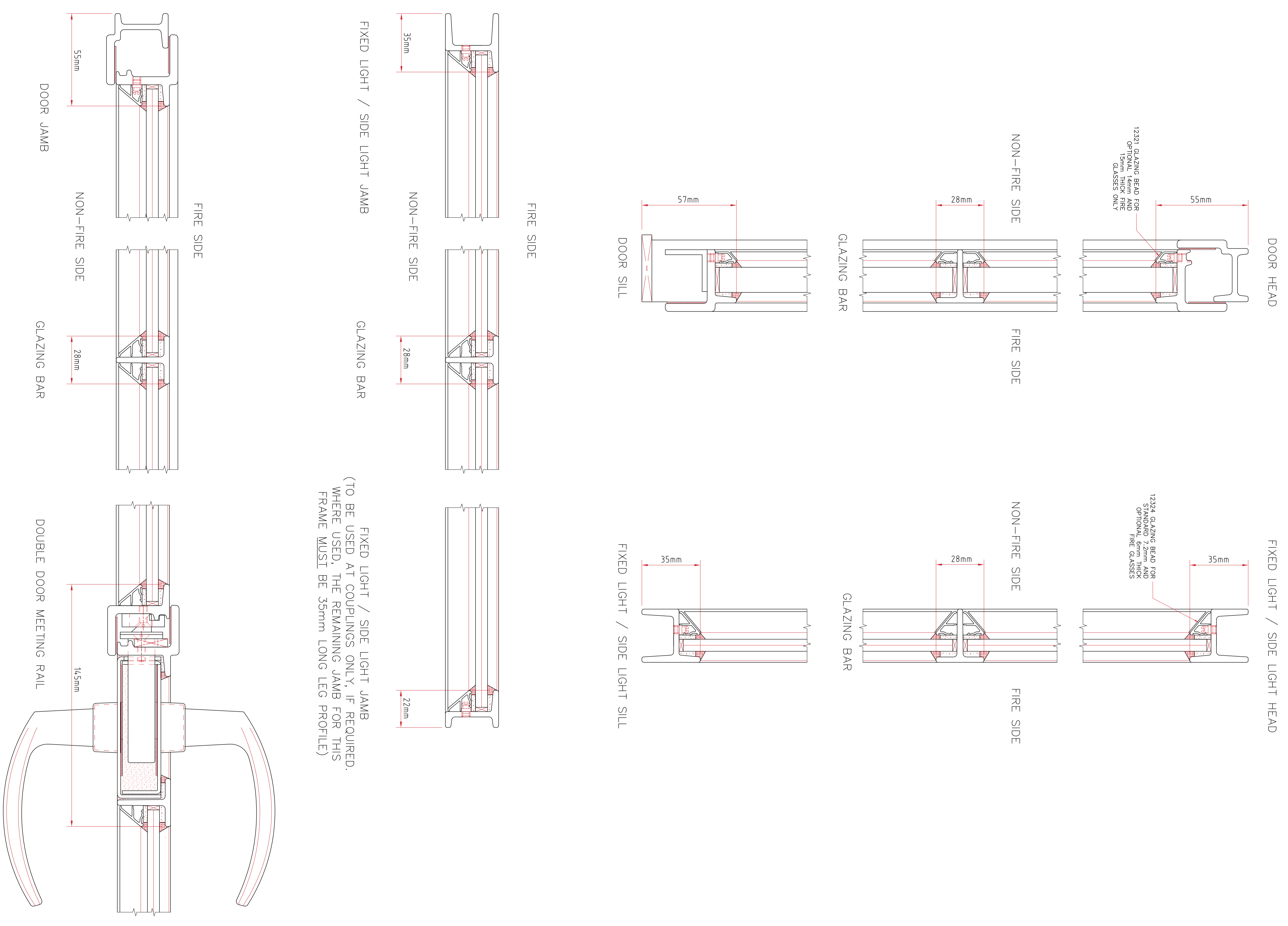

PERMITTED FRAME PROFILES

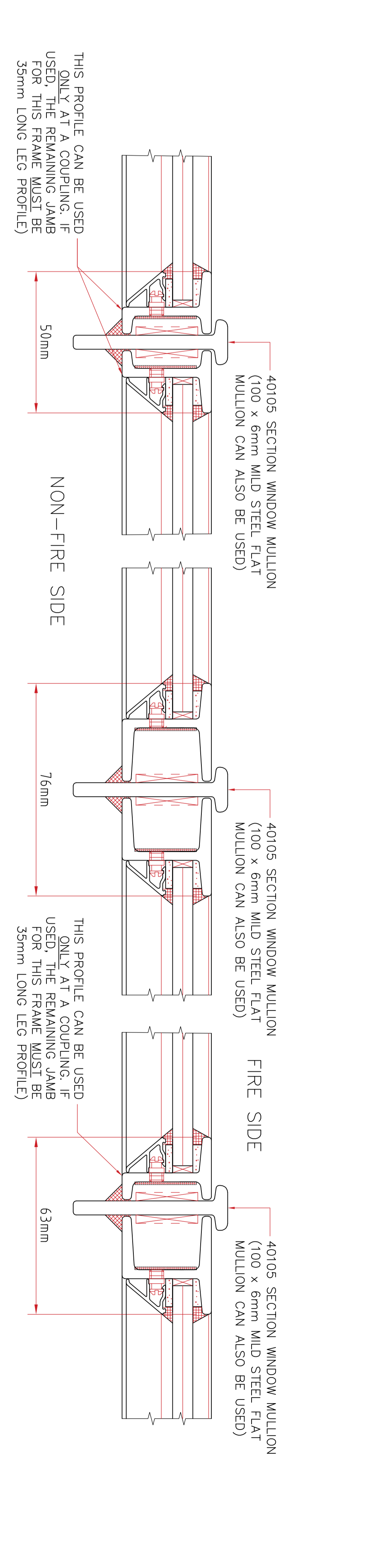
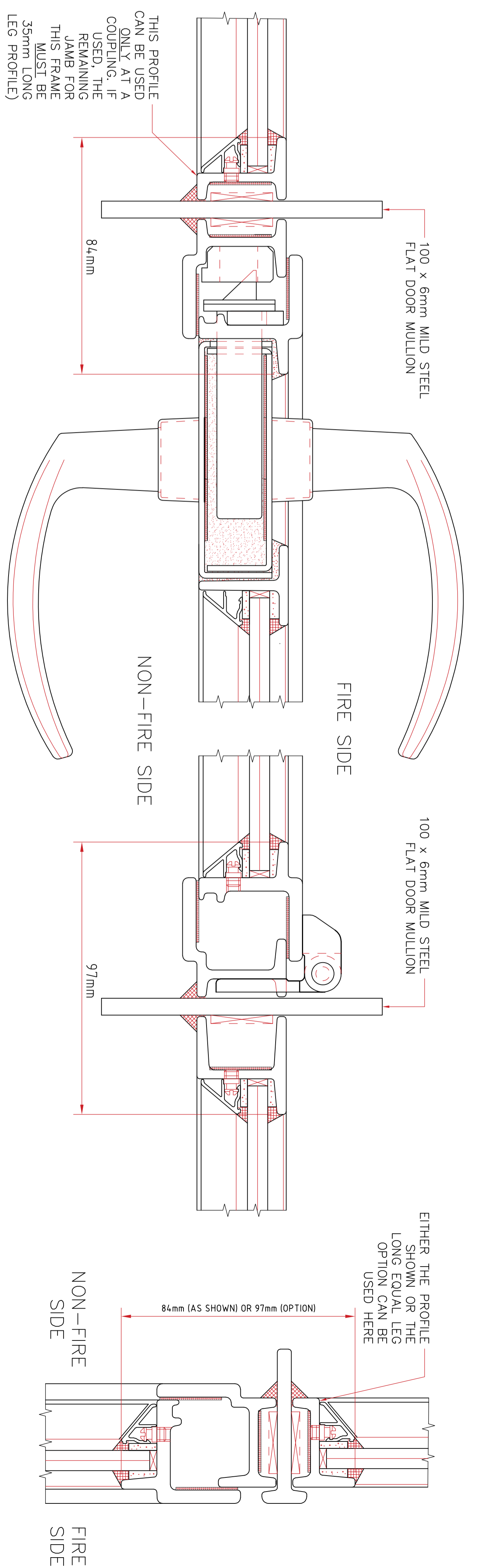

PERMITTED COUPLING DETAILS

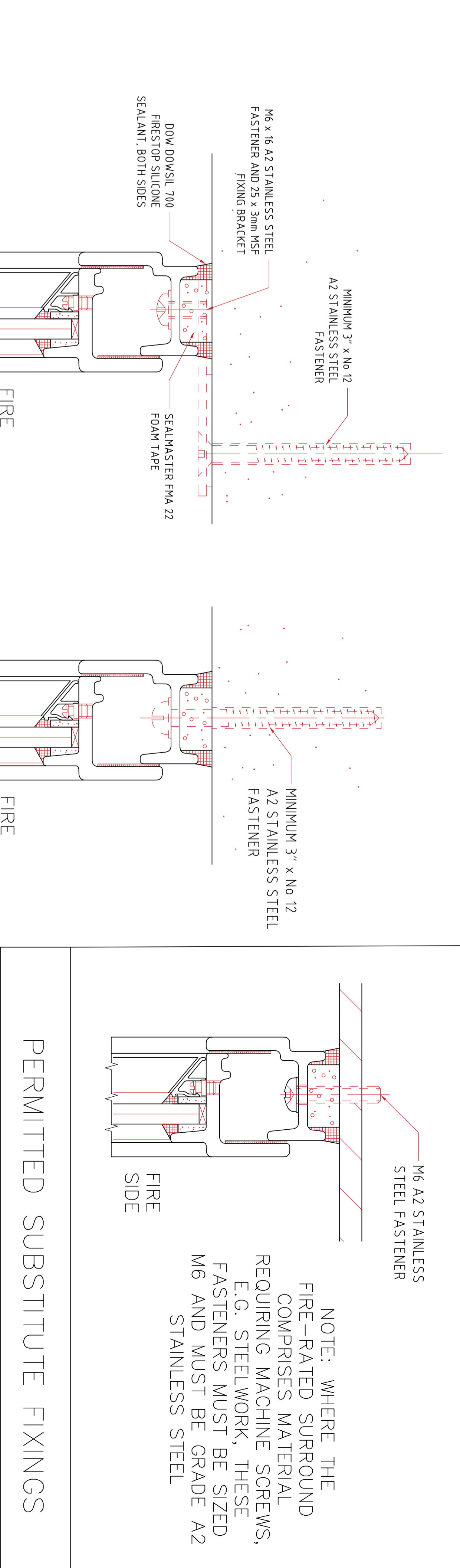

PERMITTED SUBSTITUTE FIXINGS

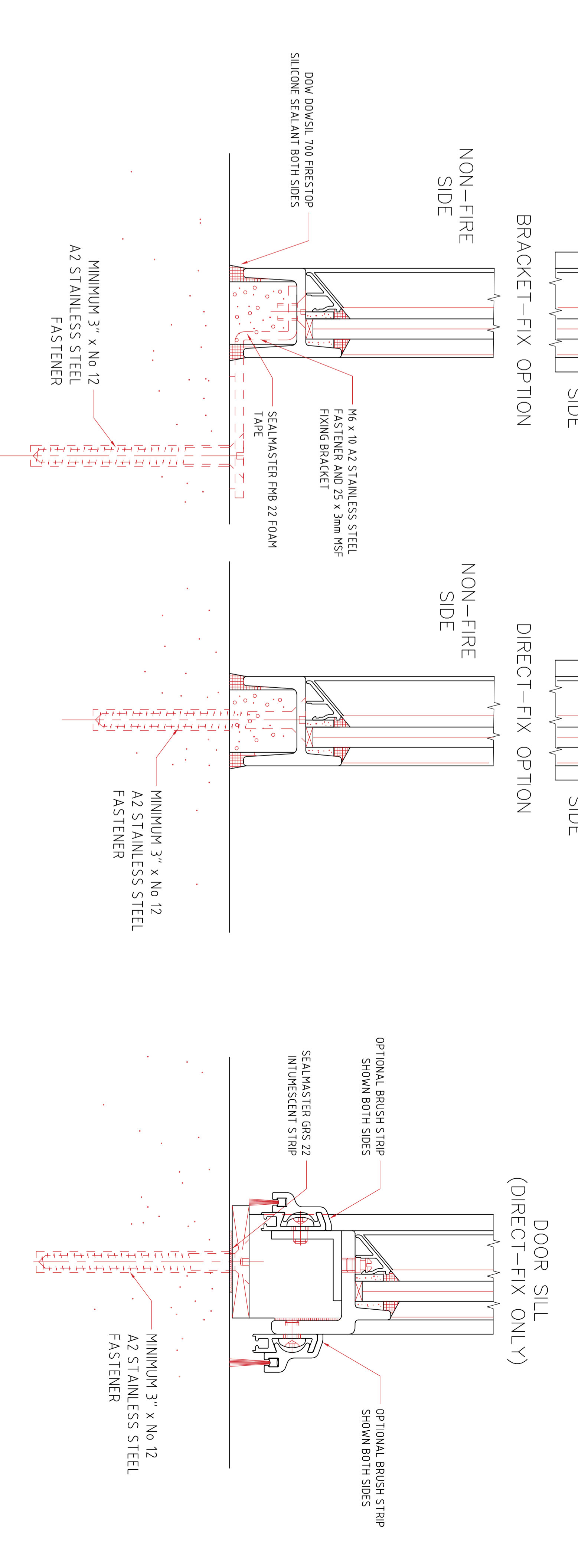

PERMITTED BOUNDARY DETAILS (BOUNDARIES MUST BE FIRE RATED)

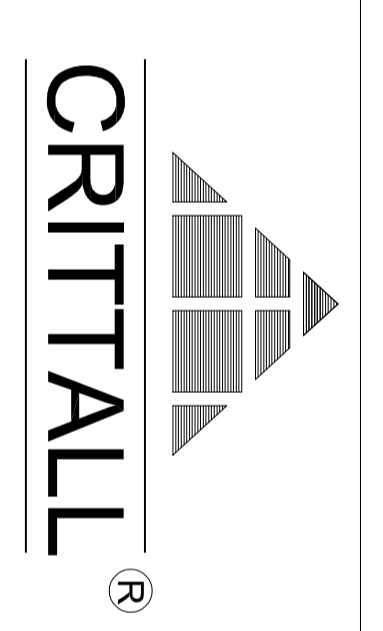

INNERVISION™ FR - FD30 FIRE RATED DOORS & FIXED LIGHTS - GENERAL ARRANGEMENT

REF: IVB 03/22 SHEET 2 OF 2

CRITTALL® IS A REGISTERED TRADE MARK OF CRITTALL WINDOWS LIMITED